

MORE[®]



195MEF1835C_EF1835C_181116 IV

EF1835C

cod. 195MEF1835C

Use, maintenance and spare parts manual

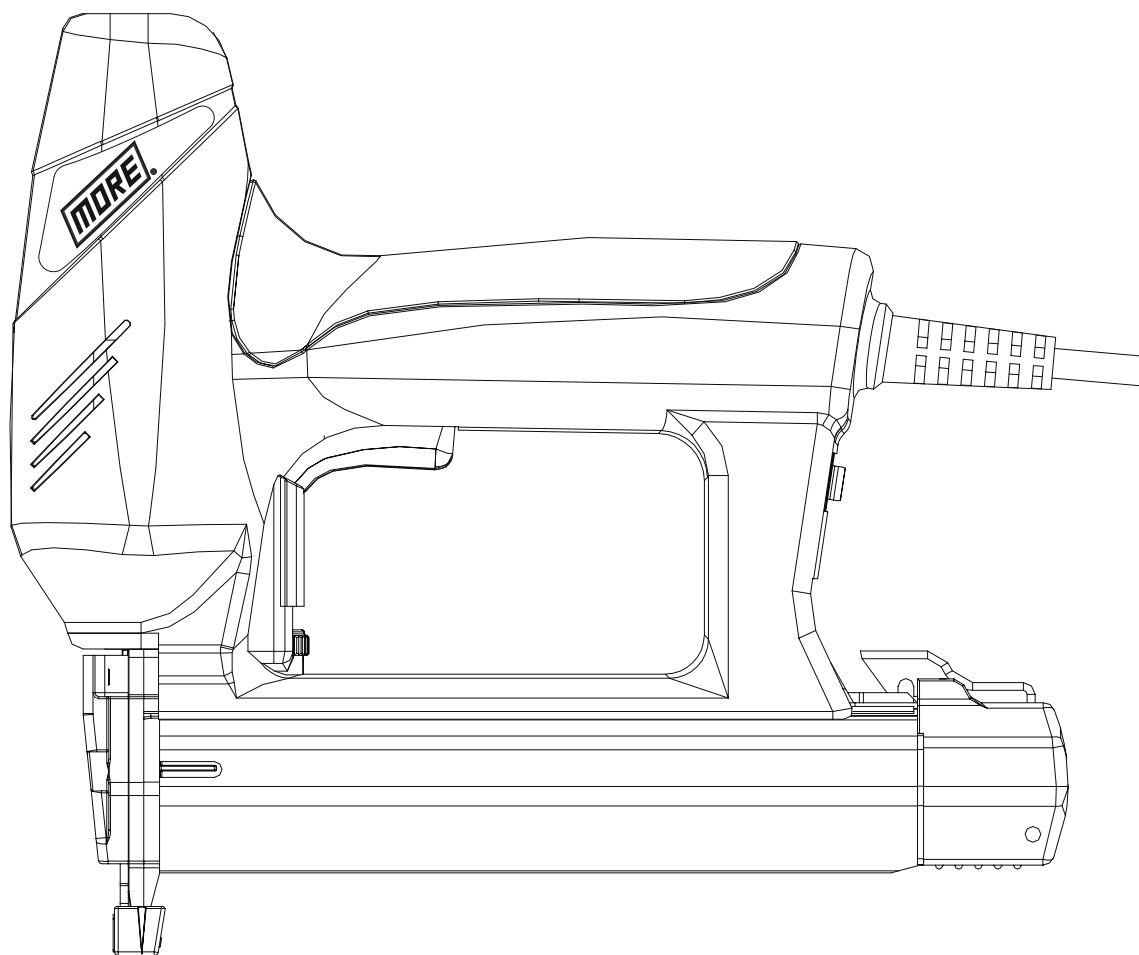

READ SAFETY RULES & INSTRUCTIONS CAREFULLY BEFORE YOU OPERATE THIS TOOL.



Distributed by

omer s.p.a.

Via Foresto, 42 - 31058 SUSEGANA (TV) ITALY
Tel. 0438 455 318 Fax 0438 455 530

Warning ! When using electric tools, basic safety precautions, including the following, should always be followed to reduce the risk of fire, electric shock and personal injury. Read all these instructions before operating this product and save these instructions.
Attention ! Always follow the safety rules and instructions in this manual. The manufacturer will not accept any responsibility for damage caused by improper use of the tacker.

Index

- | | |
|----------------------------|---------------------------|
| 1. Diagram | 7. Operating instructions |
| 2. Technical data | 8. Clearance of jamming |
| 3. Noise and vibration | 9. Maintenance |
| 4. Foreword | 10. WEEE Directives |
| 5. General safety rules | 11. Exploded view |
| 6. Instruction of safe use | 12. Parts list |

1. Diagram

- | No. | Descriptions |
|-----|---------------------|
| 01. | Non-slip soft grip |
| 02. | Power cord |
| 03. | On/Off switch |
| 04. | Safety trigger |
| 05. | Quick release latch |

- | No. | Descriptions |
|-----|----------------|
| 06. | Hex key wrench |
| 07. | Magazine seat |
| 08. | Guide plate |
| 09. | Protector shoe |

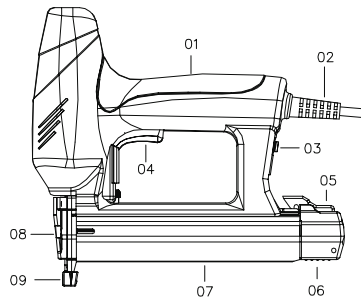

2. Technical data

Model	EF18/35C
Length	270mm (10.63")
Width	68mm (2.68")
Height	240mm (9.45")
Power	AC220-240V, 50Hz
Rated power	600W
Max. drive speed	30 Shots/minute
Magazine capacity	100 pcs
Loading system	Side loading
Fastener length	Nail 10-35mm, Staple 15-30mm
Weight	1,9 kg (4.18 lbs)
Year	2007

3. Noise and vibration

Noise characteristic values in accordance with **EN ISO3744**

A-weighted single-event sound pressure level at operator's position LpA..... 74.42 dB(A)
A-weighted sound power level LwA..... 87.42 dB(A)

Vibration characteristic values in accordance with **ISO8662-11**

Weighted root mean square acceleration..... 3.47 m/s²

4. Foreword

This electric (combination) tacker is designed for moulding, hobbies, and most other jobs requiring a hammer. Its well balanced, ergonomic, comfort non-slip cushioned grip and heavy duty driving up to 35mm nails/30mm staples ensure you a satisfactory tackle and enjoy work. Which equipped with protective shoe prevents damage to soft surfaces, features long protruding nose to nail/staple into tight corners/grooves, easy loading alum. extrusion magazine are exactly what master needed. No more painful hammering.

Suitable applications:

Wood and wood like applications, MDF, Hobby/Craft, fine decorative trim, beading and moulding. Tongue & Groove paneling. Cabinet and plywood assembly, garden furniture and trellis work, door/window assembly, hardwood flooring, paneling and trim. Picture/mirror frames. Sub-flooring and many more.... This electric tool is restricted to using on wood, wood like products, leather and material of paper. Any other material is forbidden.

Caution:

Not suitable for stapling or nailing into concrete, masonry bricks or steel. Do not fire if nails are jammed, as this will cause damage to the driver blade.

5. General safety rules

WARNING! Read all instructions. Failure to follow all instructions listed below may result in electric shock, fire and/or serious injury. The term "power tool" in all of the warnings listed below refers to your mains operated (corded) power tool or battery operated cordless power tool.

SAVE THESE INSTRUCTIONS

1. Work area

- a. **Keep work area clean and well lit.** Cluttered and dark areas invite accidents.
- b. **Do not operate power tools in explosive atmospheres, such as in the presence of flammable liquids, gases or dust.** Power tools create sparks which may ignite the dust or fumes.
- c. **Keep children and bystanders away while operating a power tool.** Distractions can cause you to lose control.

2. Electrical safety

- a. **Power tool plugs must match the outlet. Never modify the plug in any way. Do not use any adapter plugs with earthed (grounded) power tools.** Unmodified plugs and matching outlets will reduce risk of electric shock.
- b. **Avoid body contact with earthed or grounded surfaces such as pipes, radiators, ranges and refrigerators.** There is an increased risk of electric shock if your body is earthed or grounded.
- c. **Do not expose power tools to rain or wet conditions.** Water entering a power tool will increase the risk of electric shock.
- d. **Do not abuse the cord. Never use the cord for carrying, pulling or unplugging the power tool. Keep cord away from heat, oil, sharp edges or moving parts.** Damaged or entangled cords increase the risk of electric shock.
- e. **When operating a power tool outdoors, use an extension cord suitable for outdoor use.** Use of a cord suitable for outdoor use reduces the risk of electric shock.

3. Personal safety

- a. **Stay alert, watch what you are doing and use common sense when operating a power tool. Do not use a power tool while you are tired or under the influence of drugs, alcohol or medication.** A moment of inattention while operating power tools may result in serious personal injury.
- b. **Use safety equipment. Always wear eye protection.** Safety equipment such as dust mask, non-skid safety shoes, hard hat, or hearing protection used for appropriate conditions will reduce personal injuries.
- c. **Avoid accidental starting. Ensure the switch is in the off position before plugging in.** Carrying power tools with your finger on the switch or plugging in power tools that have the switch on invites accidents.
- d. **Remove any adjusting key or wrench before turning the power tool on.** A wrench or a key left attached to a rotating part of the power tool may result in personal injury.
- e. **Do not overreach. Keep proper footing and balance at all times.** This enables better control of the power tool in unexpected situations.
- f. **Dress properly. Do not wear loose clothing or jewellery. Keep your hair, clothing and gloves away from moving parts.** Loose clothes, jewellery or long hair can be caught in moving parts.
- g. **If devices are provided for the connection of dust extraction and collection facilities, ensure these are connected and properly used.** Use of these devices can reduce dust related hazards.

4. Power tool use and care

- a. **Do not force the power tool. Use the correct power tool for your application.** The correct power tool will do the job better and safer at the rate for which it was designed.
- b. **Do not use the power tool if the switch does not turn it on and off.** Any power tool that cannot be controlled with the switch is dangerous and must be repaired.
- c. **Disconnect the plug from the power source before making any adjustments, changing accessories, or storing power tools.** Such preventive safety measures reduce the risk of starting the power tool accidentally.
- d. **Store idle power tools out of the reach of children and do not allow persons unfamiliar with the power tool or these instructions to operate the power tool.** Power tools are dangerous in the hands of untrained users.
- e. **Maintain power tools. Check for misalignment or binding of moving parts, breakage of parts and any other condition that may affect the power tools operation. If damaged, have the power tool repaired before use.** Many accidents are caused by poorly maintained power tools.
- f. **Keep cutting tools sharp and clean.** Properly maintained cutting tools with sharp cutting edges are less likely to bind and are easier to control.
- g. **Use the power tool, accessories and tool bits etc., in accordance with these instructions and in the manner intended for the particular type of power tool, taking into account the working conditions and the work to be performed.** Use of the power tool for operations different from intended could result in a hazardous situation.

5. Service

- a. **Have your power tool serviced by a qualified repair person using only identical replacement parts.** This will ensure that the safety of the power tool is maintained.

6. Instructions for safe use



Note !

- This cordless tool is restricted to using on wood, wood like products, leather and material of paper. Any other material is forbidden.



Caution !

- Not suitable for stapling or nailing into concrete, masonry, bricks or steel.
- Do not fire if nails are jammed, as this will cause damage to the driver blade.
- The supply voltage must correspond to the voltage shown on the tacker.
- The electrical supply must be single-phase and in accordance with the standards in force. Never connect the tacker to a three-phase supply or to motor-powered generators.
- Keep the cable away from sharp edges in order to avoid a short circuit and fire risk.
- Do not exceed the maximum average firing rate. You are recommended to leave it to cool down, if the tacker overheats or driving times stipulated.

- Do not rest a hand on the trigger during loading or as a habit.
- The driving force may be impaired by extension cord too long or too thin, by deteriorated plugs.



Read this manual and understand all safety instructions before operation the tool. If you have any questions, please contact our authorized representatives.



Employers and users are responsible for ensuring user or anyone near the tool wear this safety protection.



Protect your eyes and ears. Wear z87.1 safety glasses with side shields.



Staples or nails leaving the nose are dangerous and may cause injuries. Never point tool at yourself or at any other person.



Do not place your hand or any part of your body in the fastener discharge area of the tool when connecting or disconnecting air supply.



Carry the tacker at workplace using only the hand grip and never with the trigger actuated. Never carry the tacker by cable or pull the cable to move.

List of fasteners for EF18/35C :

Crown	Shank		Length	Gauge
	Thickness	Width		
	1.0mm	1.25mm	Nail 10-35mm	18
5.8mm	1.0mm	1.25mm	Staple 15-30mm	18

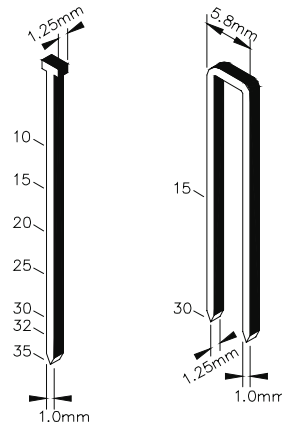

Loading instructions:

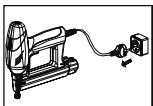

1. Disconnect power source.

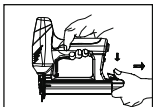

2. Unlock the magazine by releasing latch in the back, and slid-open the magazine.

A. Loading nails:

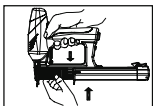

3. Load selected nail strip (nail points facing downwards) into the track of the magazine-the head of he nail can go above and below the locating rails.

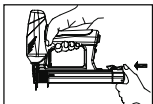

4. Push the track back until release latch clicks. (A click sound from the latch indicates it has been locked properly.)

B. Loading staples :

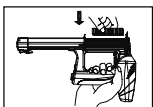

5. Place the tool upside-down, and load staple strip in magazine rail so that the crown of the staple (top flat part) is in the uppermost of magazine.

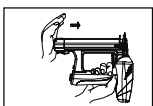

6. Push the track back until release latch clicks. (A click sound from the latch indicates it has been locked properly.)

7. Operating instructions

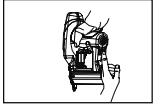

1. Turn the power switch in "OFF" position (O).
2. Plug tool into 220-240V~50Hz power outlet.
3. Grip the tool firmly and hold against work piece.
4. Turn the power switch in "ON" position.

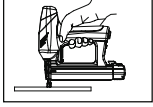

5. Press the safety yoke hard enough to activate trigger.

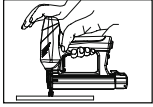

6. If necessary, place palm of free hand on top of the tool to achieve better penetration.

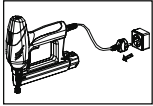

7. Always disconnect the tacker from the power supply after use.

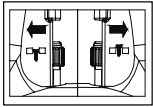

8. Penetration adjustment
Turn adjusting knob left to lower (A)
And right to raise (B).

8. Clearance of jamming

In the event of malfunctions caused by jammed staples or nails proceed as follows :

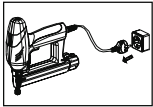

1. Disconnect main plug.

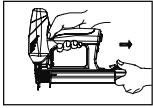

2. Release latch and slide open the magazine.

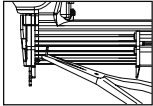

3. Grad jammed fasteners with pliers and remove.

9. Maintenance

- Disconnect main plug and unload the magazine.
- Clean the magazine space, guide plate and other active parts with a jet of compressed air.
- It is recommended to put one drop of machine oil on the driver slide area. Do not lubricate the internal parts of the tacker.
- Never use solvent or other liquids in cleaning this tool.
- Do not use or keep the tacker in wet or dusty locations.
- Do not disassemble or alter the tacker. All defective or non-working machines should be repaired only by fully trained technician.

10. WEEE Directives



Do not dispose of electrical appliances as unsorted municipal waste, use separate collection facilities.

Contact your local government for information regarding the collection systems available.

If electrical appliances are disposed of in landfills or dumps, hazardous substances can leak into the groundwater and get into the food chain, damaging your health and well-being.



When replacing old appliances with new ones, the retailer is legally obligated to take back your old appliance for disposal at least for free of charge.

11. Exploded view

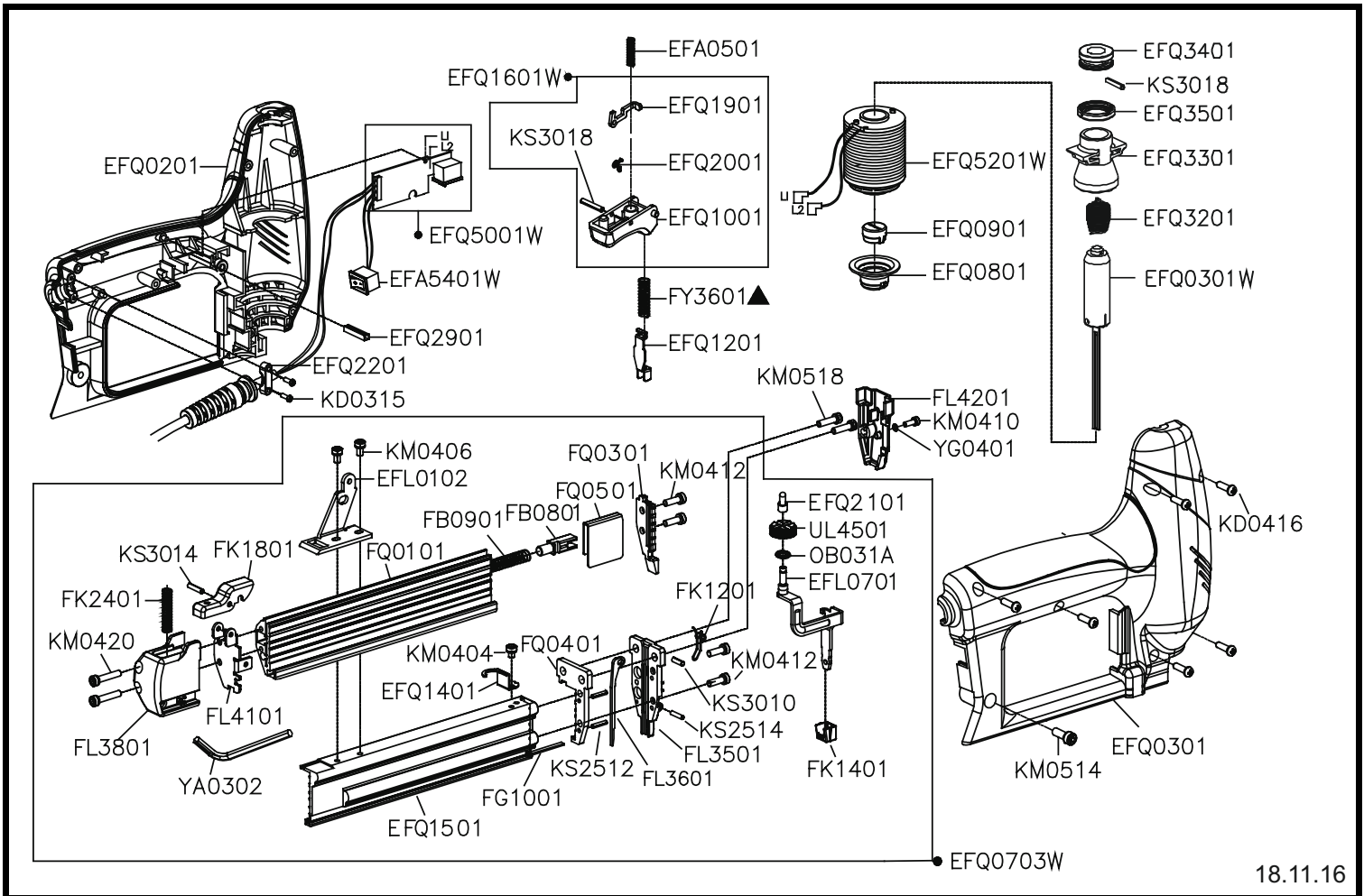

18.11.16

12. Parts list

Part_No	Description	Q'ty	Part_No	Description	Q'ty	Part_No	Description	Q'ty
EFA0501	SPRING	1	EFQ3301	UPPER BUMPER	1	FY3601	COMPRESSION SPRING	1
EFA5401	POWER SWITCH ASSY.	1	EFQ3401	PISTON STOP	1	KD0315	SCREW	2
EFL0102	SUPPORT	1	EFQ3501	PU CUSHION	1	KD0416	SCREW	6
EFL0701	WORK CONTACTING	1	EFQ5001	PCB ASSY.	1	KM0404	HEX.SOC.HD.BOLT	1
EFQ0201	FRONT BODY	1	EFQ5201	COIL ASSY.	1	KM0406	HEX.SOC.HD.BOLT	2
EFQ0301	REAR BODY	1	FB0801	PUSHER PIN	1	KM0410	HEX.SOC.HD.BOLT	1
EFQ0301W	DRIVER ASSY.	1	FB0901	PUSHER SPRING	1	KM0412	HEX.SOC.HD.BOLT	4
EFQ0703	MAGAZINE ASSY.	1	FG1001	BAR	1	KM0420	HEX.SOC.HD.BOLT	2
EFQ0801	BUMPER COVER	1	FK1201	SPRING	1	KM0514	HEX.SOC.HD.BOLT	1
EFQ0901	BUMPER	1	FK1401	SAFETY CUSHION	1	KM0518	HEX.SOC.HD.BOLT	2
EFQ1001	TRIGGER	1	FK1801	LATCH	1	KS2512	SPRING PIN	2
EFQ1201	SAFETY	1	FK2401	COMPRESSION SPRING	1	KS2514	SPRING PIN	1
EFQ1401	FIXED PLATE	1	FL3501	COVER PLATE	1	KS3010	SPRING PIN	1
EFQ1501	MAGAZINE SEAT	1	FL3601	GUIDE PLATE	1	KS3014	SPRING PIN	1
EFQ1601	TRIGGER ASSY.	1	FL3801	COVER	1	KS3018	SPRING PIN	2
EFQ1901	CONTACT LEVER	1	FL4101	STOP PLATE	1	OB031A	O-RING	1
EFQ2001	SPRING	1	FL4201	PLATE	1	UL4501	ADJUSTING WHEEL	1
EFQ2101	FIXED	1	FQ0101	MAGAZINE CAP	1	YA0302	HEX BAR WRENCH	1
EFQ2201	FIXTURE	1	FQ0301	FRONT PLATE	1	YG0401	SPRING WASHER	1
EFQ2901	STOP PLATE	1	FQ0401	GUIDE PLATE	1			
EFQ3201	PULL SPRING	1	FQ0501	PUSHER	1			